

15122023-2.0



MANUAL LEVER HOIST TRR- TRSSR (type HSH) OPERATING MANUAL



1.1 Product purpose	3
1.2 Technical specifications	3
1.3 Precautions	5
2. Usage instructions	6
2.1 Preparation for use	6
2.2 Operating instructions	7
2.3 Operating precautions	8
3. Care after use	9
4. Inspection procedures	9
4.1 Precautions	9
4.2 Records and reports	10
4.3 Everyday inspection	10
5. Hoists not in regular use	11
6. Trouble shooting	13
7. WARRANTY	14

1. Description and Operation

1.1 Product purpose

IMPORTANT SAFETY INFORMATION

Please read, understand and follow all safety information contained in these instructions prior to the use of this hoist.

Retain these instructions for further use. These instructions are applicable for Manually Operated Lever Chain Hoists.

INTENDED USE

This hoist is designed to be used to lift or pull a load from a stationary position. Use in any other manner or with other accessories could lead to unsafe operating conditions.

WARNING

This unit must only be used in compliance with all applicable safety regulations and standards, including ASME B30.21, concerning installation, use, maintenance and inspection of equipment lifting devices.

1.2 Technical specifications

Item No.	Lifting capacity, t	Lifting height, m	Arm force, kg	Weight, kg	Thickness of power chain, mm	Pitch of the power chain link, mm	Number of branches, units.	
1006098	0,5	No chain	14,8	7,8	5	15	X1+0,3 M	1
1005756		1,5		8,6				
10253		3		9,1				
10256		6		10,0				
10259		9		12,0				
102512		12		14,0				
102750	0,75	No chain	18	7,8	6	18	X1+0,3 M	1
1005758		1,5		8,5				
102753		3		9,0				
102756		6		11,7				
102759		9		14,4				
1027512		12		17,1				
1006156	1,0	No chain	20	7,8	6	18	X1+0,3 M	1
1005759		1,5		8,5				
10213		3		9,0				
10216		6		11,7				
10219		9		14,4				
102112		12		17,1				
102150	1,5	No chain	21,6	9,1	8	24	X1+0,3 M	1
10215105		1,5		11,5				
102153		3		13,9				
102156		6		18,7				
102159		9		23,5				
1021512		12		28,3				
1006172	2,0	No chain	33,6	10,1	8	24	X1+0,3	1

Item No.	Lifting capacity, t	Lifting height, m	Arm force, kg	Weight, kg	Thickness of power chain, mm	Pitch of the power chain link, mm	Number of branches, units.	
1005760		1,5		11,5			M	
10223		3		12,6				
10226		6		17,4				
10229		9		22,2				
102212		12		27,0				
10230	3,0	No chain	33,6	14,9	10	30	X1+0,3 M	1
1005761		1,5		18,5				
10233		3		22,0				
10236		6		29,0				
10239		9		36,0				
102312		12		43,0				
1006888	6,0	No chain	34,5	29,8	10	30	X2+0,5 M	2
1005762		1,5		33,4				
10263		3		37,0				
10266		6		51,4				
10269		9		65,8				
102612		12		80,2				
1008227	9,0	1,5	37	43,4	10	30	X3+0,5 M	3
10293		3		47,0				
10296		6		63,8				
10299		9		80,6				
102912		12		97,4				

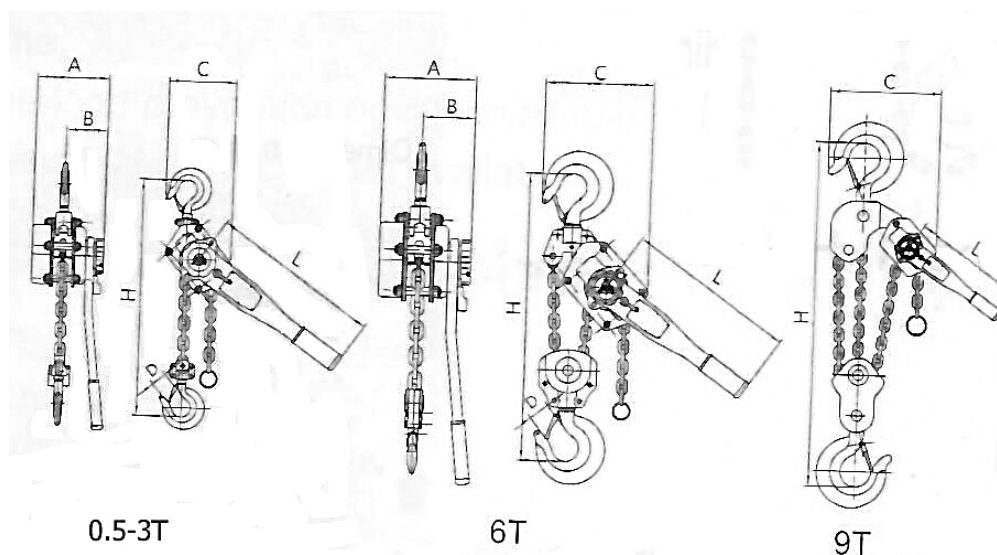

Fig. 1 - Basic dimensions of the hoist

The main indicators of the lever hoist

Payload, tons	Dimensions, mm						Package dimensions, mm
	A	B	C	D	L	H	
0,5	148	88	135	32	290	320	370x140x170
0,75	148	88	135	32	290	320	370x140x170
1,0	148	88	135	32	290	320	370x140x170
1,5	176	102	155	36	415	380	520x140x180
2,0	176	102	155	36	415	380	520x140x180
3,0	195	109	211	46	415	480	550x160x210
6,0	195	109	254	46	415	600	550x160x210
9,0	195	109	319	57	415	700	620x485x260

1.3 Precautions

- Read, understand and follow the safety information contained in these instructions prior to using this tool. Keep these instructions for further reference.
- Do not exceed rated capacity. Hooks and handles are designed to bend or stretch when overloading is detected.
 - Never use handle extensions (cheaters).
 - During operation always ensure a firm footing. Operate the hoist from a location that will be clear of the load at all times. People must stay clear of load at all times. Never use the hoist to lift, support, or transport people. Never lift loads over or near people.
 - Before lifting a load, confirm that the lever hoist is in good condition and functioning properly. Inspect the lever hoist regularly. Never use a lever hoist when malfunction, unusual performance, damage, or extensive wear are found.
 - Always keep the load chain well lubricated and protect it from weld spatter and other damaging contaminants. Never allow the load chain or hooks be used as a ground for welding and never touch them with live welding electrodes.

- Never use the lever hoist with twisted, kinked, damaged or worn load chains. Never attempt to lengthen the load chain.
- Always use proper slings and attachments in the correct manner and confirm that they are seated properly in the hook.
- Also confirm that the safety latch assembly has closed completely and not supporting any part of the load.
- Slacked load chain must be taken up carefully. While checking the balance of the load, lift and lower the load about 4" to test the brake system before lifting further. Loads must be lifted slowly.
- Never run the load chain out beyond the range of the hoist.
- Never allow your attention to be diverted when operating the hoist and never leave a suspended load unattended.
- Do not allow a load to drop, such as over the edge of a platform, while connected to a lever hoist. The sudden drop, even of a small distance, can cause a severe momentary overload, seriously damaging the lever hoist and possibly resulting in the loss of the load. This can occur at loads rated well below the rated capacity.
- Never adjust or repair a lever hoist unless you are qualified to perform hoist maintenance.
- Never modify the lever hoist. Approval from PTA is required for all nonstandard maintenance.
- Use only genuine PTA parts when repairing the lever hoist.
- Never remove or obscure the name plate on the lever hoist.
- PTA hoists are rated for use between -20 to +60 °C. Humidity 100% or below. These are not underwater devices.

2. Usage instructions

2.1 Preparation for use

- Inspect carefully for any damage that may occur during shipping. Check for loose, missing, or damaged parts.
- Lubricate the load chain along the whole length with machine oil (See Fig. 1).
- Examine the load chain to ensure that there are no twists. 6 ton lever hoists have 2 falls of load chain. Twists can arise from the bottom hook being accidentally turned over through the load chains (See Fig. 2).
- Confirm that the supporting structure is strong enough to support the full rated capacity of the lever hoist with a generous factor of safety.

Lubrication

Ensure the bottom hook block has NOT been flipped through the chain falls.

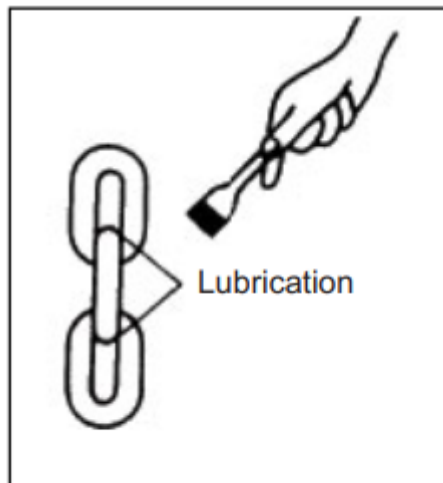

FIGURE 1

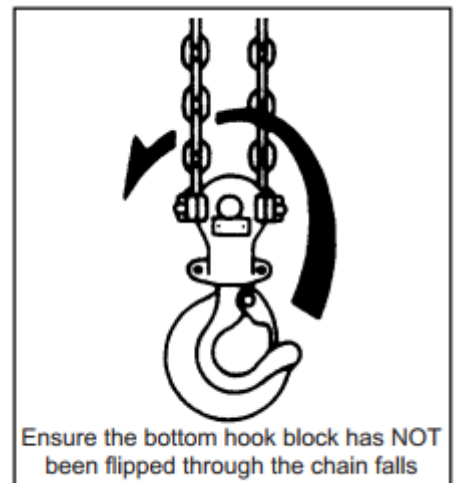

FIGURE 2

2.2 Operating instructions

Hoisting (Pulling)

- Set the selector lever to the "UP" position. Take up the slacked load chain by turning the guide handle clockwise or by free wheeling (instructions below). Next, Manipulate the operating handle clockwise.

Lowering (Releasing)

- Set the selector lever to the "DOWN" position. Manipulate the operating handle counterclockwise. When there is no load on the lever hoist, the load chain can be slacked by turning the guide handle counterclockwise.

Free-Wheeling

This operation allows for the user to quickly make large adjustments to the load chain length. Set the selector lever to the "N" position and pull the load chain out in the desired direction.

Free-Wheeling will not be possible during the following conditions:

- When the lever hoist is under a load.
- When the guide handle is in contact with something and not rotating freely.
- When the brake has locked from a large or abrupt load, turn the guide handle 45 degrees counterclockwise to unlock the brake.
- When the brake is locked.
- The brake can be unlocked by setting the selector lever to the "DOWN" position and manipulating the operating handle counterclockwise.

The lever hoist will automatically change from the free-wheeling condition to the brake locked condition when a load is applied.

Apply the load with one of the following two methods:

- Turn the guide handle clockwise until the brake locks from the force of the load.
- Pull firmly non-load side of the chain until the brake locks from the force of the load (See Figure 3, 4). Turn the selector lever to the "UP" position and hoist or pull by manipulating the operating handle.

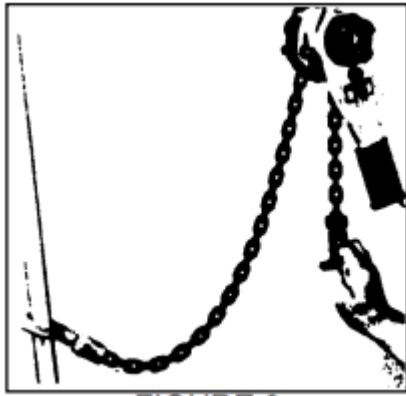

FIGURE 3

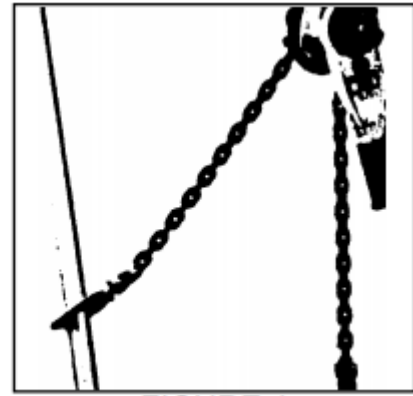

FIGURE 4

2.3 Operating precautions

- Keep the load within the rated capacity marked on the lever hoist. An excess load may lead to an accident.

LOAD LIMITED: the lever hoist is overloaded when pulling the lever arm will not lift the load and instead slips during levering. If the lever hoist is shock loaded, overloading is apparent if you cannot raise or lower the load and if the bottom hook is stretched so far that the clasp has sprung outwards.

NON-LOAD LIMITED: the lever hoist is overloaded when the lever handle is bent or the clasp on the load hook will no longer close.

- Before operating, lift and lower the load about 4" (10cm) and test the braking system. Ineffective braking may lead to an accident.

- Loads must be lifted as slowly as possible. Load swinging and abrupt shocks will impose excessive stress on the lever hoist and could lead to overloading or brake locking.

- Extreme temperatures will affect the durability of the lever hoist. In subzero temperatures, loads must be lifted and lowered very slowly and carefully.

- When hooking, the load must be applied squarely to the centre of the hook and the hook must not come loose during operation. Never use the hook directly on a load (See Figure 5). Lift loads only with applicable clamps or hooks (See Figure 6).

- Mount the top hook for a fixed location. Ensure the fixed suspension point rests on the centre of the hooks saddle and that the hook's safety latch is engaged.

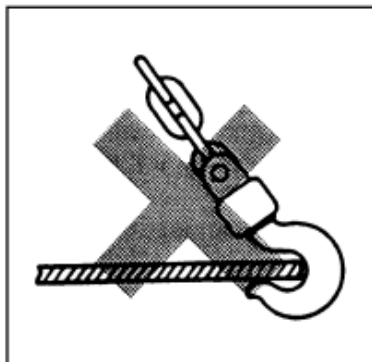

FIGURE 5

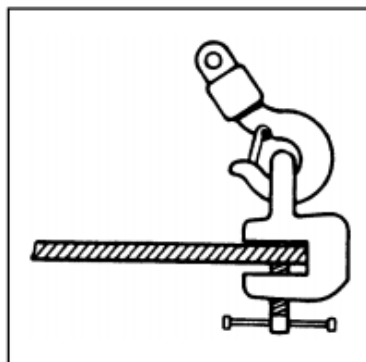

FIGURE 6

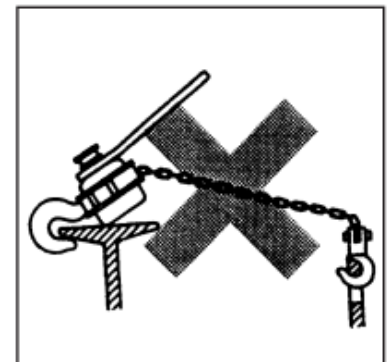

FIGURE 7

Figures 7 through 10 show improper hooking methods, which may cause the hook to elongate or bend. These hooking methods may also obstruct the load chain and prevent the lever hoist from operating properly. In applications similar these, be sure to use the correct slings and attachments to ensure safe operation and long life of the lever hoist.



FIGURE 8

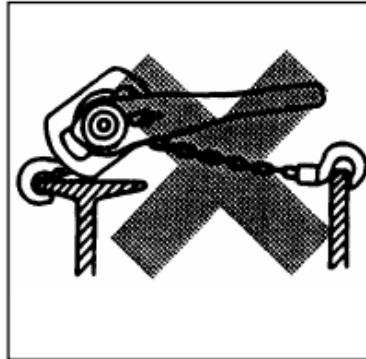

FIGURE 9



FIGURE 10

Never run the chain out too far. When the lever hoist is run out beyond the range of the lift, a dangerous excessive load is imposed on the load chain, chain safety stop, and bearings.

- The selector lever must be set to the "UP" position when the lever hoist is under a load during hoisting or pulling.
- Lifting a load with two lever hoists is NOT RECOMMENDED. When lifting a load with more than one hoist, always ensure that both hoists can lift the entire load individually.
- Do not throw or drop the lever hoist from high places. Do not drag the lever hoist during transportation. Doing so may cause damage that may lead to an accident.

3. Care after use

- Never leave or store the lever hoist with the brake system locked. Loosen the brake system by operating the lever hoist as if lowering a load.
- Always service and repair the lever hoist after use. Thoroughly clean the dust or if used in the rain, wipe off the dirt and moisture. Lubricate all moving parts of the hoist after use, especially the load chain, to prevent rust.
- Inspect the hooks and load chain for bends and any other type of defects. Also check to see if the hooks freely rotate.

If any defect is found, replace the defective component before using the lever hoist again.

4. Inspection procedures

4.1 Precautions

- All new, altered or modified equipment should be inspected and tested by personnel trained in the safety, operation and maintenance of this equipment to ensure safe operation at rated specifications before placing equipment in service.

- Frequent and Periodic inspections should be performed on equipment in regular service.
- Frequent inspections are visual examinations performed by operators or service personnel and include observations made during routine equipment operation.
- Periodic inspections are thorough inspections conducted by personnel trained in the safety, operation and maintenance of this equipment.
- ASME B30.21 states inspection intervals depend up the nature of the critical components of the equipment and severity of usage.
- Deficiencies revealed through inspection or operation must be reported to designated personnel trained in safety, operation and maintenance of this equipment. Any corrective action must be completed and documented by written report before placing the equipment in service.

4.2 Records and reports

- Inspection records should be maintained for all load bearing equipment requiring periodic inspection. Written reports should be made on the condition of the critical parts as a method of documenting periodic inspection. These reports should be dated, signed by the person who performed the inspection, and kept on file where they are readily available for review.

4.3 Everyday inspection

- The Manual Lever Chain Hoist should be inspected at the beginning of each shift. Visual inspections should also be conducted during regular service for any damage or evidence of malfunction which appears between regular inspections.

» **OPERATION:** check for visual signs or abnormal noises which could indicate a potential problem. Do not operate a hoist unless the chain feeds through the hoist and hook block smoothly. If the chain binds, jumps or is excessively noisy, clean and lubricate the chain. Do not operate the hoist until all problems have been corrected. The bottom hook should stop moving when the lever stops moving.

» **HOOKS:** check for wear and damage monthly. This includes: cracks, twists, latch engagement and latch operation (See Figure 11). Replace hooks that exceed the throat opening discard width (See Inspection Criteria). If the hook latch snaps past the tip of the hook, the hook has been overloaded and must be replaced. Check the hook support bearings for lubrication and damage. Check that hooks swivel easily and smoothly. Repair or lubricate as needed.

» **HOOK LATCHES:** check operation of hook latches. Replace if broken or missing. Ensure they catch the tip of hook.

» **CHAIN:** examine each link for bending, cracks in weld areas or shoulders, transverse nicks and gouges, weld spatter, corrosion pits, striation (minute parallel lines) and chain wear, including bearing surfaces between chain links (See Figure 12). Replace a chain that fails any of these inspections. Check lubrication and lubricate if necessary.

» **LOAD CHAIN REEVING:** make sure welds on standing links are away from the load sheave. Reinstall chain if necessary (See Figure 13). Make sure chain is not capsized, twisted or kinked (See Figure 2 & 3). Adjust as required.

» **HAND LEVER:** check for cracks, bending and other damage. Replace if necessary.

4.4 Periodic inspection

• According to ASME B30.21, frequency of periodic inspection depends on the severity of usage.

Normal	Heavy	Severe
Yearly	Semiannually	Quarterly

• Disassembly may be required for HEAVY or SEVERE usage. Any deficiencies must be corrected before hoist is returned to service. Keep records of periodic inspections to provide a basis for continuing evaluation. Inspect all items in 'Frequent Inspection'. Also inspect the following:

- » Chain for excessive wear or stretch.
- » Worn, cracked or distorted parts such as hook blocks, top hooks, chain guide, stripper, loose end pin, shafts, gears, hook collar and bearings.
- » Inspect for wear on the top of the pawl, teeth of the ratchet and pockets of the liftwheel and handwheel.
- » Loose or missing bolts, nuts, pints or rivets.
- » Inspect brake components for worn, glazed or contaminated friction discs and scoring of the handwheel hub, ratchet and friction hub.
- » Corroded, stretched or broken pawl spring.
- » Free movement of the pawl on the pawl stud.
- » Hook inspections using dye penetrant, magnetic particle or other suitable crack-detecting inspections should be performed at least once per year, if external conditions indicate possible unusual usage.
- » Ensure chain stopper is installed in the last link of the anchor end of the load chain. Replace if missing.

5. Hoists not in regular use

• A hoist that has been idle for a period of one month or more should be given an Frequent Inspection before use.

• A hoist that has been idle for a period longer than on year should be given a Periodic Inspection before use.

• Standby hoists should be inspected at least semiannually in accordance with the Everyday Inspection. In abnormal operating conditions this inspection should be completed at shorter intervals.

Inspection criteria

- The lever hoist is designed and manufactured to withstand heavy duty material handling operations, but wear and damage are unavoidable after an extended use in less than ideal environments.

- Never leave the hoist in a damp environment or damp weather such as rain. Always store the hoist in a dry, well ventilated area.

- Proper lubrication will help lengthen the life of the lever hoist. Before storing, check to see if the hoist is well lubricated.

Be especially sure that the moving parts, such as gears and bearings, are well lubricated.

- Load chain and hooks

Note: the load chains and hooks are precisely heat-treated.

Never weld or heat-treat the load chain.

Load Chain

Load chains worn-out or elongated beyond the permissible dimensions must be replaced at once. To examine, clean the chain with an acid-free solvent and, using a calliper style gauge, measure the inside length of 5 links of chain under light tension. Replace the entire load chain immediately if even one link of the load chain is extensively worn-out, elongated or damaged.

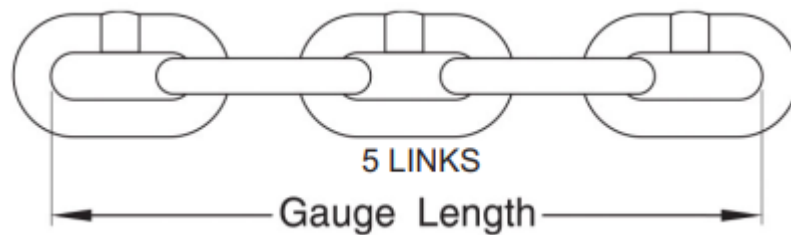

LOAD CHAIN DIMENSIONS

CAPACITY (TONS)	DIAMETER (Ø mm)	STANDARD* (Ø mm)	LIMIT* (mm)
3/4	6	89.9	92.6
1-1/2	8	119.8	123.4
3	10	149.6	154.1
6	10	149.6	154.1

*5 link inner diameter dimensions

Hooks

PTA material handling hooks are designed to bend slightly when overloaded. If the hook opening is elongated beyond the permissible dimension, the hook is dangerously deformed and must be repaired at once. No deformation of the hook will arise when the lever hoist is used and maintained properly.

HOOK DIMENSIONS

CAPACITY (TONS)	STANDARD C SIZE (mm)	LIMIT C SIZE* (mm)
3/4	30	33.0
1-1/2	34	37.4
3	40	44.0
6	50	55.0

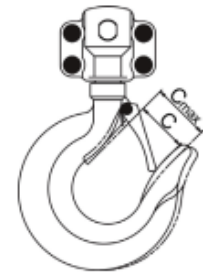

*Limit C size is 10% wider than the standard hook opening. The safety latch will not catch the hook tip once the hook is stretched beyond this point.

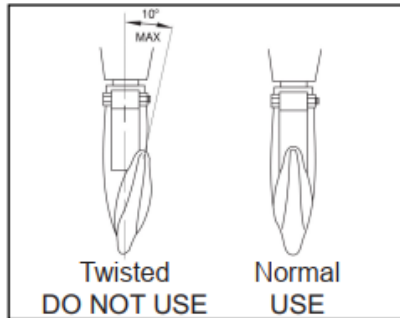

FIGURE 11

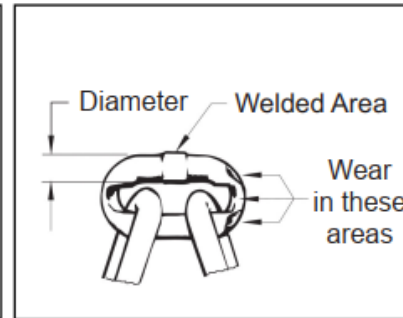

FIGURE 12

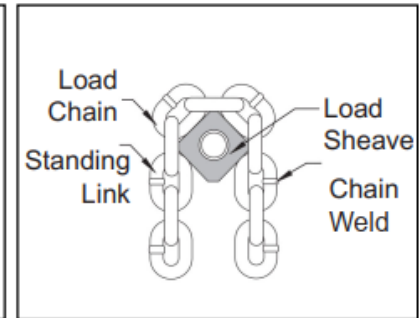

FIGURE 13

6. Trouble shooting

CONDITION	PROBABLE CAUSE	HOW TO REPAIR
Hoist will not lift load	<ol style="list-style-type: none"> 1. Excess slack in load chain. 2. Hoist is overloaded. 3. Hoist is in NEUTRAL (N) mode 	<ol style="list-style-type: none"> 1. Pull down on load chain while ratcheting until slack is removed and hoist begins lifting load 2. Reduce load to within rated capacity 3. Ensure selector lever is in UP position.
Slip caused by ineffective braking	<ol style="list-style-type: none"> 1. Worn-out friction discs. 2. Excessive oil on the braking surface. 3. Incorrect assembly of the braking system. 	<ol style="list-style-type: none"> 1. Replace with new friction discs. 2. Disassemble and clean. 3. Assemble correctly.
Load dropped while lowering	<ol style="list-style-type: none"> 1. Damaged friction discs. 2. Foreign matters in the braking system. 	<ol style="list-style-type: none"> 1. Replace with new friction discs. 2. Disassemble and clean.
Load chain binds	<ol style="list-style-type: none"> 1. Damaged load chain, pinion shaft, gears or sheaves. 2. Load chain not installed properly (twisted, kinked or capsized). 	<ol style="list-style-type: none"> 1. Disassemble and inspect components. 2. Inspect and adjust or repair.
Jammed operating handle	<ol style="list-style-type: none"> 1. Over-tightening of the brake. 	<ol style="list-style-type: none"> 1. Operate lever hoist as if lowering a load.
Noises during hoisting and lowering operation	<ol style="list-style-type: none"> 1. Wear or deformation of the load chain and load sheave. 	<ol style="list-style-type: none"> 1. Replace with new parts.
Operating handle becomes difficult to operate during lifting or lowering operation	<ol style="list-style-type: none"> 1. Over-hoisting or over-lowering. 2. Twist in the load chain causing it to get caught between load sheave and load chain guide. 	<ol style="list-style-type: none"> 1. Operate the hoist in opposite direction. 2. Operate the hoist in the opposite direction and remove the twist from the load chain.
Load will not go down	<ol style="list-style-type: none"> 1. The hoist was left under load for extended period. 2. Over tightened brake. 3. Shock loaded during operation. 4. Brake rusted tight. 	<ol style="list-style-type: none"> 1. For non-load limited hoists, set the selector lever to the down position then pull hard on the lever. This may reset the brake. 2-4. If load cannot be moved, use another lifting device to remove the load from the affected hoist and replace brake components and perform hoist maintenance.

⚠ WARNING

**IMPROPER lever hoist use could result in death or serious injury.
To AVOID these hazards:**



NEVER
throw a hoist.



NEVER
use the hoist
chain as a sling.



NEVER
use an extended
pipe or bar on
handle.



NEVER
operate so far that
the hook or chain
stopper link
touches the block.

⚠ WARNING

**IMPROPER lever hoist use could result in death or serious injury.
To AVOID these hazards:**



NEVER
support a load
on the tip of the
hook.

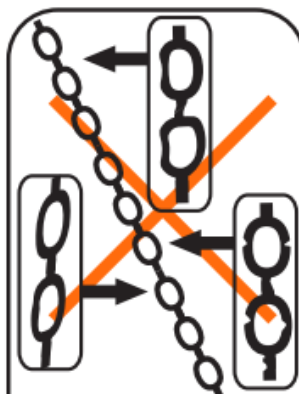

NEVER
use a twisted,
kinked, damaged,
or stretched load
chain.



NEVER
use a hoist if the
hook latch is
missing or
broken.

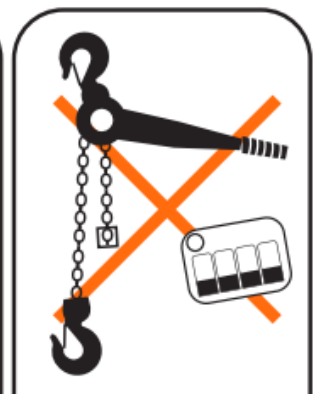

NEVER
remove or
obscure the
warning tags.

7. WARRANTY

The warranty period is 12 months from the date of sale to the end customer.

LIMITATION OF LIABILITY:

- Seller will not be liable for product failures caused by use and normal wear and tear.

- The Seller is not responsible for product malfunctions caused by non-observance of operating rules or use of the Product under unacceptable environmental conditions.

- The warranty will be voided if the Product is not regularly serviced and if it is improperly stored.

- This warranty will not be extended to any Product that has been subject to misuse, neglect or accident or which will have been altered or repaired by elements other than Seller's in such a manner as to adversely affect its performance, stability or reability.

- The warranty does not cover the Product that has suffered any mechanical damage.

- The warranty does not apply to a Product that has been altered in any way.

In order to determine the causes of failure, a technical check is carried out for a period of 10 working days from the date of receipt of the Product for diagnosis.

Claims filing:

- Claims concerning found defects can be issued by the Buyer to the Seller within the guarantee period. The Buyer may request a claim form and instructions for filing a claim from the Seller.

- All risks associated with delivery of the Product to the dealer or service center are borne by the owner of the Product.

- Claims related to incompleteness and appearance of the Product will not be accepted after it has been put into operation.



The information in this paragraph is current at the time of printing of this manual. Up-to-date information on warranty service rules is published on the official website of the group of companies TOR INDUSTRIES **www.tor-industries.com** ("Service" section).

PRODUCT PASSPORT

Product Information:

Model	
--------------	--

Serial No.	
-------------------	--

Sale Date		/		/	
------------------	--	---	--	---	--

Warranty Period	
------------------------	--

Seller Information:

Company	
----------------	--

Address	
----------------	--

Phone	
--------------	--

SERVICE MARKS

Place for Stamp	All control operations and tests have been carried out. The product is fully equipped, serviceable and ready for use.
Dated: <input type="text"/>	

Maintenance and repair

Type of Maintenance						
----------------------------	--	--	--	--	--	--

Type of Maintenance						
----------------------------	--	--	--	--	--	--

Type of Maintenance						
----------------------------	--	--	--	--	--	--

Type of Maintenance						
----------------------------	--	--	--	--	--	--

Warranty Repair						
------------------------	--	--	--	--	--	--

Repair						
---------------	--	--	--	--	--	--

Date of Maintenance						
---------------------	--	--	--	--	--	--

Contractor						
------------	--	--	--	--	--	--

The customer confirms that he has familiarized himself with the rules of use of the product. The customer received the manual in English. The customer has no claims to the serviceability, appearance and completeness of the product.

Customer Signature _____

Place for Stamp

